

Connecting Saf-T Vent® EZ Seal to Appliances and Other Saf-T Vent Products

EZ Seal IS Compatible with Existing Heat-fab Products. Here's how:

1. Connecting to an Appliance Flue Collar

- If the flue collar that comes with the appliance has Heat-fab's integral red seal, you may attach EZ Seal pipe and fittings directly to it. Make the joint as described in the EZ Seal installation instructions (Pub # PI-EZ).

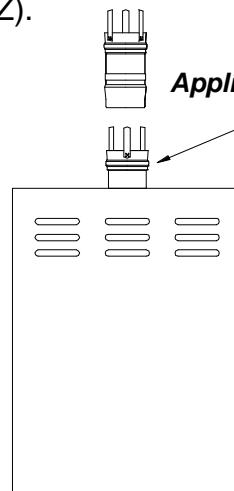
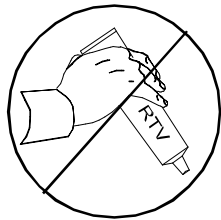

***Appliance flue collar has Heat-fab's integral red seal.
No sealant required.***

- If the flue collar has Heat-fab's female end (with the 3 tabs) but does not have the integral red seal, you will need to use an approved high-temperature RTV silicone sealant to make the joint between the flue collar and the first piece of EZ Seal. The rest of the system can be sealant-free if it is all EZ Seal.

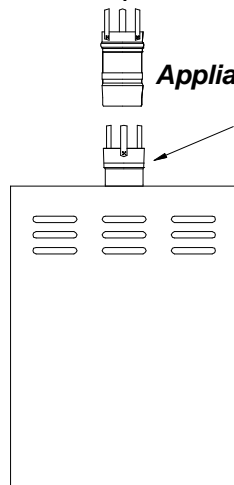
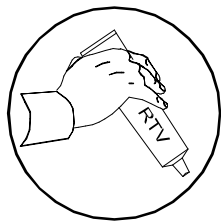

***Appliance flue collar has Heat-fab's female expand
but no integral red seal.
Sealant is required to attach to flue collar.***

2. Connecting an EZ Seal Appliance Adapter to the Appliance

- If the EZ Seal appliance adapter has been designed for a sealant-free connection to the appliance, it will have an integral red seal in the female end and in the end that attaches to the appliance.

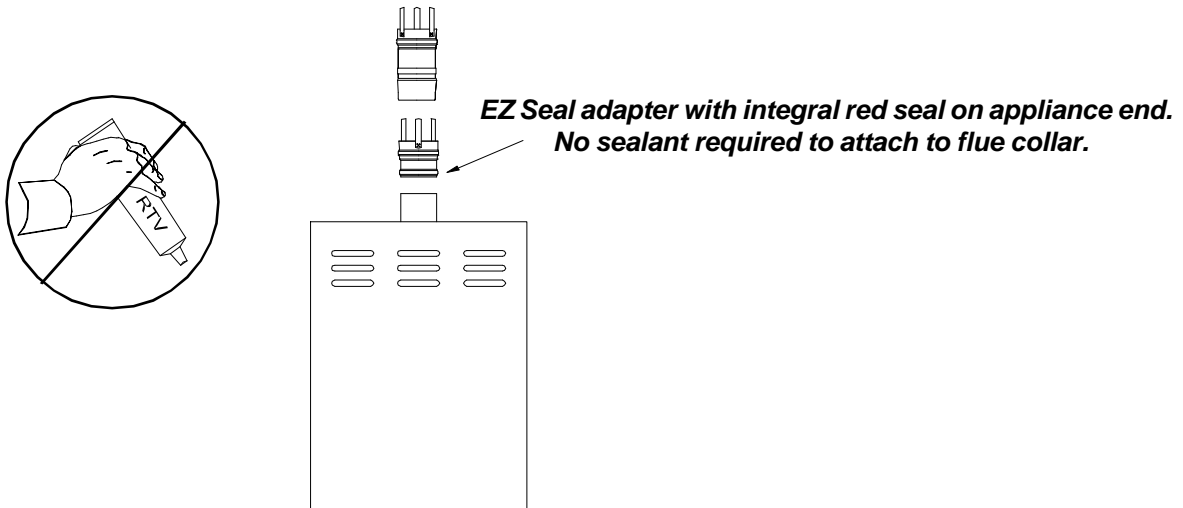

- If the integral red seal is only in the female end, you will need to use an approved high-temperature RTV silicone sealant to make the connection to the appliance. Follow the procedure recommended by the appliance manufacturer.

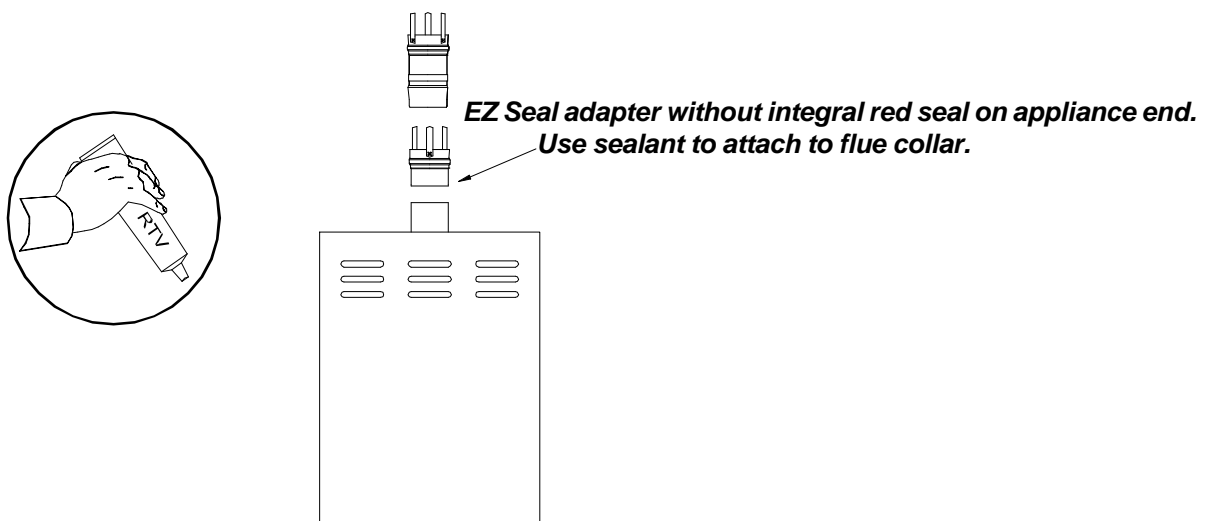

3. Connecting EZ Seal to Saf-T Vent GC (single-wall) or Saf-T Vent CI (double-wall)

- Saf-T Vent GC and Saf-T Vent CI lack the integral red seal. When you connect EZ Seal to them you will need to use an approved high-temperature RTV silicone sealant. Follow the procedure outlined in the GC or CI installation instructions (Pub # PI-VBH or PI-CIINS).

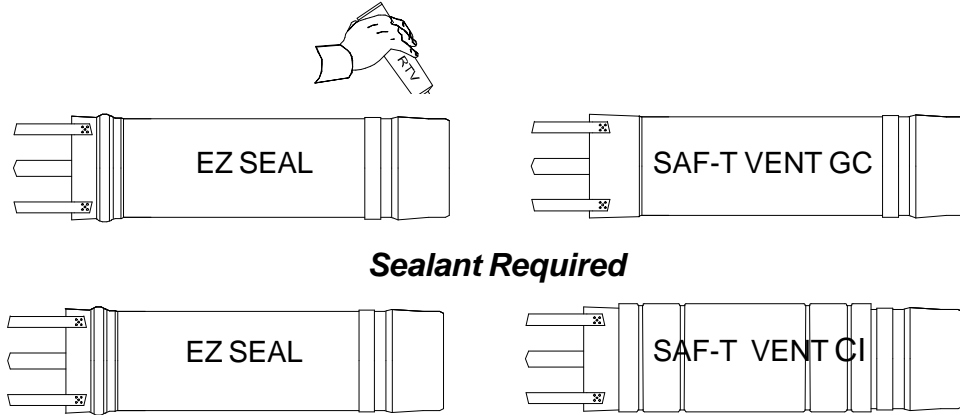

4. Attaching Saf-T Vent Terminations to EZ Seal

- Existing Saf-T Vent Terminations (rain cap, screen termination, elbow termination, tee termination, mitered termination, and others) can be used with the EZ Seal system. Simply insert the termination into the female end of the last section of EZ Seal, and then make the ring-and-tab connection as you normally would.

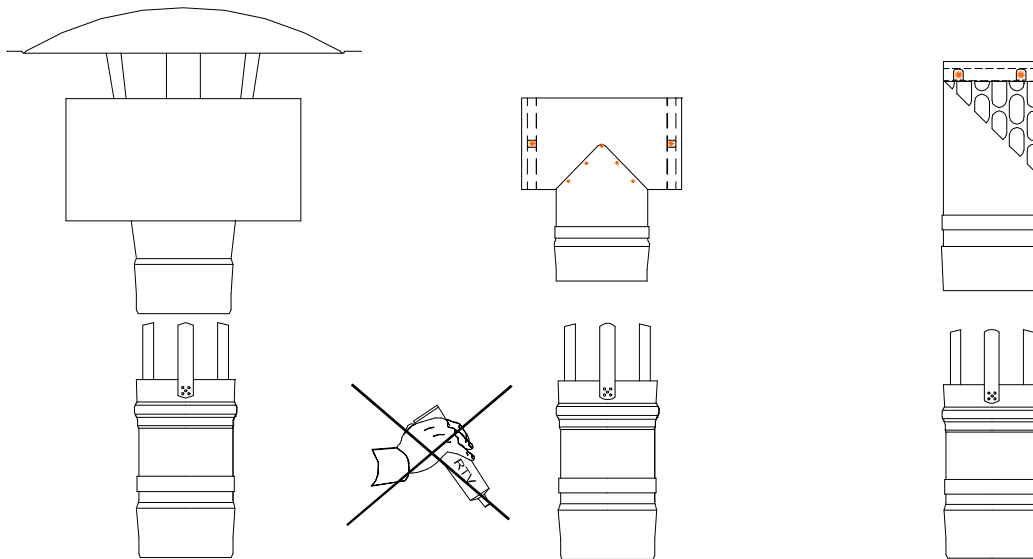

Termination attaching to EZ Seal, NO sealant required.

5. Connecting Saf-T Vent GC or Saf-T Vent CI to EZ Seal

- Saf-T Vent GC and Saf-T Vent CI sections and fittings may be attached to an EZ Seal system:
- If the male end (without tabs) of the GC or CI part was made with a butt-weld (a single layer of steel at the weld area), the part can be attached to an EZ Seal female end without using sealant.
- If the male end was made with an overlapped weld (two layers of steel at the weld area), the joint must be made using an approved high-temperature RTV silicone sealant. Follow the procedure outlined in the GC or CI installation instructions (Pub # PI-VBH or PI-CIINS).

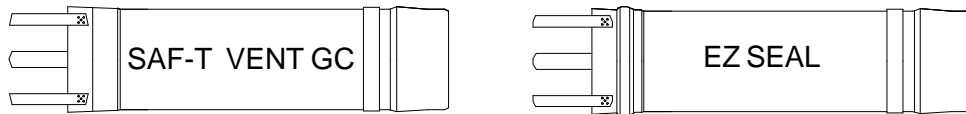

Use of Sealant Depends on the Type of Weld

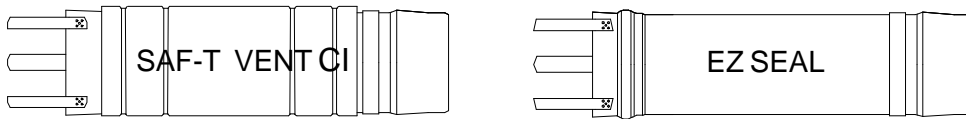

End View of a Saf-T Vent GC or CI Section or Fitting

**Butt Weld
Single Layer of Steel**

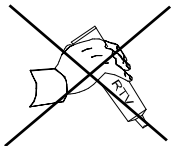
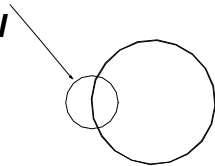

No Sealant required

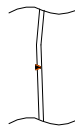

**Overlap Weld
Two Layers of Steel**

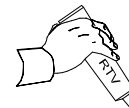
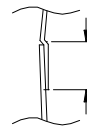
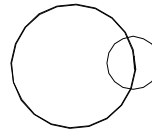

Sealant required